



eidos

For safe use of this product, carefully read the following section of this manual and the Precautions section of the instruction manual supplied with the PSP (PlayStation®Portable) entertainment system before use. Retain both this software manual and the instruction manual for future reference.

Health precautions

- When operating the unit, play in a well-lit room and keep a safe distance from the screen.
- Avoid prolonged use of the system. Take a break of about 15 minutes during every hour of play.
- Do not use the system when you are tired or short of sleep.
- When using headphones, do not turn the volume up before putting the headphones on. Also, do not listen at loud volume levels for extended periods of time. Stop using the system immediately if you experience any of the following symptoms. If the condition persists, consult a doctor.
- Lightheadedness, nausea, or a sensation similar to motion sickness.
- Discomfort or pain in the eyes, ears, hands, arms, or any other part of the body.

Use and handling precautions

- This disc is PSP™ (PlayStation®Portable) format software and is intended for use with the PSP system only. If the disc is used with other devices, damage to the disc or to the device may result.
- This disc is compatible for use with the PSP™ system marked with FOR SALE AND USE IN U.S. ONLY.
- Depending on the software, a Memory Stick™ Duo or Memory Stick™ PRO Duo (both sold separately) may be required. Refer to the software manual for full details.
- Do not use while driving or walking. Do not use in airplanes or medical facilities where use is prohibited or restricted.
- Set the PSP™ system's wireless network feature to off when using the PSP™ on trains or in other crowded locations. If used near persons with pacemakers, the signal from the PSP™ system's wireless network feature could interfere with the proper operation of the pacemaker.
- If paused images are displayed on the screen for an extended period of time, a faint image may be left permanently on the screen.
- Store the disc in its case when not in use and keep in a place out of the reach of children. If the disc is left out this may result in warping or other damage to the disc.
- Do not leave the disc in direct sunlight, near a heat source, in a car or other places subject to high heat and humidity.
- Do not touch the opening on the rear of the disc (recording surface of the disc; see drawing).
- Also, do not allow dust, sand, foreign objects or other types of dirt to get on the disc.
- Do not block the opening with paper or tape. Also, do not write on the disc.
- If the opening area does get dirty, wipe gently with a soft cloth.
- To clean the disc, wipe the exterior surface gently with a soft cloth.
- Do not use solvents such as benzene, commercially-available cleaners not intended for CDs, or anti-static spray intended for vinyl LPs as these may damage the disc.
- Do not use cracked or deformed discs or discs that have been repaired with adhesives as these may cause console damage or malfunction.
- SCE will not be held liable for damage resulting from the misuse of discs.

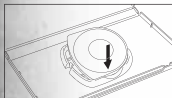
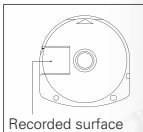

Ejecting the disc

Press the right side of the disc until it is in the position shown in the drawing and then remove it. If excess force is applied this may result in damage to the disc.

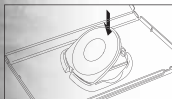

Storing the disc

Insert the bottom side of the disc and then press on the top side until it clicks into place. If the disc is not stored properly, this may result in damage to the disc.

"PlayStation" and the "PS" Family logo are registered trademarks and "PSP" and "UMD" are trademarks of Sony Computer Entertainment Inc. "Memory Stick Duo" and "Memory Stick PRO Duo" are trademarks of Sony Corporation.

CONTENTS

GETTING STARTED	2
STARTING UP	3
LARA	4
MENU CONTROLS	5
MAIN MENU	5
Start Game	5
Load	5
Croft Manor	5
Options	6
Extras	6
TOMB TRIALS	7
Single Player	7
Head-to-Head	8
DIFFICULTY LEVELS	9
SAVING AND LOADING	10
Saving Your Progress	10
Saving Rewards	10
Loading a Saved Game	11
CONTROLLING LARA	12
Movement Controls	12
Swimming Controls	13
Combat and Item Controls	14
Driving Controls	15
COMBAT	16
Combat Strategies	16
Aiming and Firing Controls	16
Melee Attacks	17
Defensive Combat Controls	18
Targeting	18
HUD (Head's-Up Display)	19
PDA	20
EQUIPMENT	21
REWARDS	23
CREDITS	24

GETTING STARTED

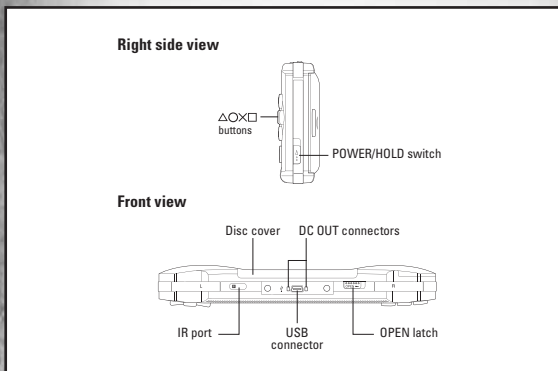

Set up your PSP™ (PlayStation®Portable) system according to the instructions in the manual supplied with the system. Turn the system on. The power indicator lights up in green and the home menu is displayed. Press the OPEN latch to open the disc cover. Insert the TOMB RAIDER: LEGEND™ disc with the label facing away from the system, slide until fully inserted and close the disc cover. From the PSP™ system's home menu, select the Game icon and then the UMD icon. A thumbnail for the software is displayed. Select the thumbnail and press the X button of the PSP™ to start the software. Follow the on-screen instructions and refer to this manual for information on using the software.

Note: Do not eject a UMD™ while it is playing.

MEMORY STICK DUO™

Warning Keep Memory Stick Duo media out of reach of small children, as the media could be swallowed by accident.

To save game settings and progress, insert a Memory Stick Duo or Memory Stick Pro Duo into the memory stick slot of your PSP. You can load saved game data from the same memory stick or any memory stick containing previously saved games.

STARTING UP

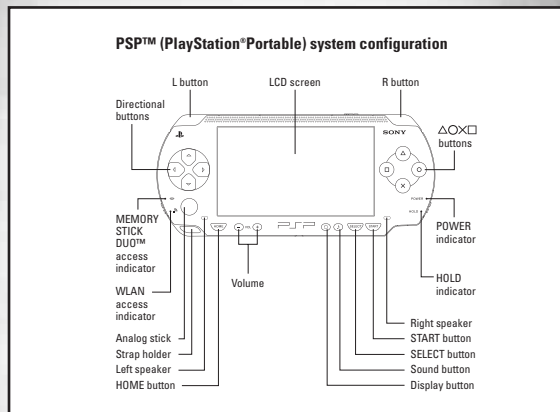

WIRELESS (WLAN) FEATURES

Software titles that support Wi-Fi functionality allow you to communicate with other PSP systems, download data and compete against other users via connection to a wireless local area network (WLAN). You can adjust the network settings to allow connection to a wireless local area network (WLAN). TOMB RAIDER: LEGEND™ supports Ad Hoc only.

- AD HOC MODE – Ad Hoc Mode is a Wifi feature that allows two or more individual PSP systems to communicate directly with each other.



LARA

At the age of nine, Lara survived a plane crash in the Himalayan mountains that led to the death of her mother. After miraculously surviving a ten-day solo trek from the crash site to Kathmandu, she spent the rest of her childhood under the close tutelage of her archeologist father – the late Earl of Abbingdon, Richard Croft.

At the age of 18, after the death of her father, Lara inherited the Croft estates and became Countess of Abbingdon. Since then she has been credited with the discovery of some 16 archeological sites of international significance.

Lara Croft has been hailed both as an Archeological wunderkind and a glorified Treasure Hunter, depending on who's talking. There are thousands of rumors surrounding Lara's exploits, invariably involving the unexplained or outright unbelievable. Lady Croft herself is rarely available for comment, which further adds to the fog of mystery that surrounds her life and work.

Consequently, Lara Croft continues to be the focus of wild speculation and intense debate. Idealized and vilified in equal measure, she is perhaps one of the most fascinating, enigmatic figures of our time.



MENU CONTROLS

Use the menu controls to adjust options from both the Main Menu and in-game Pause Menu (press the START button during play to pause).

START button	Pause/Display Pause Menu
directional buttons	Cycle through options
O button	Cancel/Previous menu
X button	Confirm/Next menu

MAIN MENU

START GAME

Start a new game.





LOAD

- **LOAD GAME** – Displays a list of saved games. Select a save and press the X button to load it.
- **LOAD LEVEL** – Displays a list of completed levels (present in the loaded save). Replay these levels to collect rewards, play in different difficulty modes, or attempt a Time Trial.

CROFT MANOR

You can visit Lara's expansive manor via the Main Menu throughout the game. However, to gain full access you must have a saved game containing at least one completed mission. Only then will all the Manor's secrets become available for you to discover.

OPTIONS

Press the analog stick or directional buttons / to select an option and / to change the setting. Press the X button to confirm your Options changes, or press the O button to return to the Main Menu without change.

- **SOUND** – Adjust the volume of MUSIC, SFX and VOICE VOLUME.
- **DISPLAY** – Use the Display Menu to adjust:
 - **SUBTITLES** – Set subtitles ON/OFF or to your preferred language.
 - **BRIGHTNESS** – Adjust the brightness of the display.
- **CAMERA** – Set the following options to YES or NO:
 - **INVERT X-AXIS**
 - **INVERT Y-AXIS**
 - **AIM & BINOCES INVERT X-AXIS**
 - **AIM & BINOCES INVERT Y-AXIS**
- **CONTROL** – View the list of in-game controls.

EXTRAS

Access information and bonus content within TOMB RAIDER: LEGEND™. By completing levels and collecting rewards along the way, you will unlock items that you can then select and view here.

Note: To view unlocked items, you must first load a saved game.





TOMB TRIALS

Tomb Trials provide a variety of exciting challenges for both single and multiplayer play. Challenges include:

- **MASTER SYSTEM** – An exciting race to the finish. Sprint, leap and dive through numerous checkpoints to reach the end before the clock expires.
- **TREASURE HUNT** – Seek out all the artifacts hidden on the level before your timer runs out.
- **RAID N' SEEK** – Hide n' seek meets capture the flag. Hide your own artifact, and race to find the opposing player's hidden item.

To access the Tomb Trials games, select one of the following options from the Main Menu:

- **SINGLE PLAYER** (below)
- **HEAD-TO-HEAD** (page 8)
- **TOMB TRIALS USER STATS** – Check your best times and achievements for each trial. Press the directional buttons / to turn pages.

SINGLE PLAYER

- **GAME MODE** – Play either MASTER SYSTEM or TREASURE HUNT.
- **CHALLENGE TYPE** (present when TREASURE HUNT game mode is selected) – Choose the difficulty of the challenge you will undertake.
- **LEVEL** – Choose a game level to play. (Various choices are available depending on your game mode.)
- **START** – Begin the single player game.

HEAD-TO-HEAD

Selecting this option takes you to the Lobby screen. From here you can send and receive game invites to and from other players. When one player accepts another's invite, the player who sent the invite can set the options below.

Note: In Head-to-Head mode you are identified by the nickname of your PSP system (set via the PSP system software). If your nickname contains a character not supported by the game, you'll see a □ symbol in its place.

- **GAME MODE** – Play either MASTER SYSTEM, TREASURE HUNT, or RAID N' SEEK.
- **NO. OF LEVELS** (present when MASTER SYSTEM game mode is selected) – Choose the number of levels you will play. (The levels you actually play will be chosen at random for you.)
- **CHALLENGE TYPE** (present when RAID N' SEEK game mode is selected) – Choose the difficulty of the challenge you will undertake.
- **NO. OF ROUNDS** (present when TREASURE HUNT game mode is selected) – Choose the number of rounds you and your opponent will play.
- **LEVEL** – Choose a game level to play. (Various choices are available depending on your game mode.)
- **START** – Begin the multiplayer game. (START will be grayed out for several seconds while the game loads.)

DIFFICULTY LEVELS

When you start a new game, you'll be prompted to select a difficulty level:

- **DIFFICULTY** – Select your game difficulty level:
 - **EXPLORER** – Easy play.
 - **ADVENTURER** – Medium difficulty.
 - **TOMB RAIDER** – Advanced challenge.

Note: Once you select a difficulty level, you will not be prompted to do so again unless you start a new game, replay a level via the LOAD LEVEL option (page 5), or begin a new level in your adventure.



SAVING AND LOADING

Press the **START** button during play to display the **Pause Menu**; from here you can save your progress and rewards and load a saved game.

SAVING YOUR PROGRESS

Every game level has several checkpoints to pass. The word **CHECKPOINT** will appear in the bottom right of the screen to inform you when Lara has passed a checkpoint. This is a good place to save your progress. Press the **START** button to access the **Pause Menu** and select **SAVE**. From here you can choose to create a new save game or overwrite an existing save.

You can also save between checkpoints, but Lara will always appear at the most recently saved checkpoint when a save is loaded again.

Note: There is no automatic save when you leave the game. However, if Lara dies during a game, she automatically restarts at the last checkpoint passed, regardless of whether or not you saved there. If you quit the game without saving, you lose all progress since the last saved checkpoint.

SAVING REWARDS

When you replay a previously completed level, you will have the option to select **SAVE REWARDS** to save any collected rewards to your current game.

LOADING A SAVED GAME

You can load any saved game on your memory stick from the **Main Menu** or from the in-game **Pause Menu**. Select **LOAD**, then choose a save from one of the four save slots. If data is present, details of the save will be shown at the right of the screen. Press the **X** button to load and resume that game.

If you have a save that was created at the end of the game, you cannot load it during gameplay. Instead, you can revisit any part of the game via the **LOAD LEVEL** option (page 5) in the **Main Menu**.

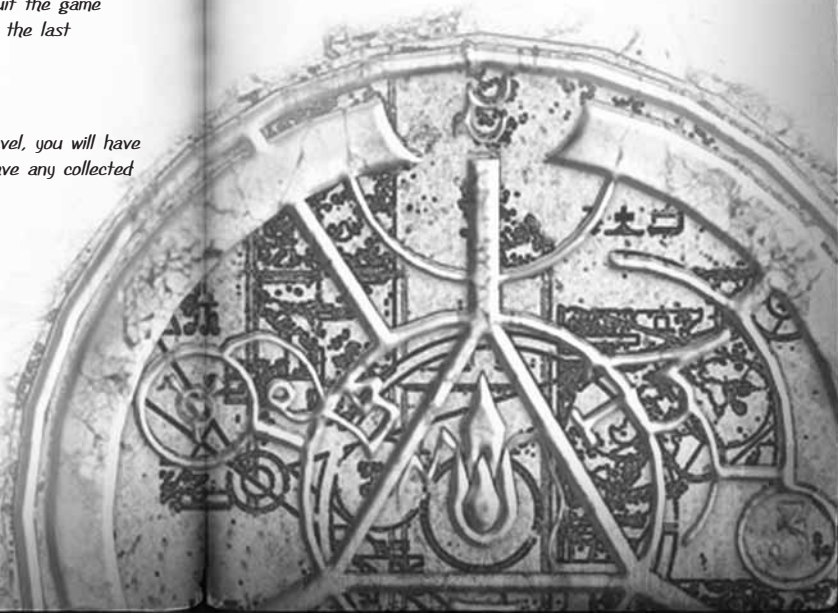

CONTROLLING LARA

The controls shown in this section are default. You can view all the CONTROL settings in the Options Menu (page 6).

MOVEMENT CONTROLS



analog stick	<i>Movement: Sneak, Walk and Run.</i>
<input type="radio"/> button	<i>Crouch/Roll.</i>
<input type="checkbox"/> button	<i>Interact/Action: while standing next to objects or vehicles. Pick up new weapon: when standing over weapon.</i>
<input type="triangle-up"/> button	<i>Safety Grab: prevent Lara from falling from ledges.</i>
<input type="cross"/> button	<i>Jump. Hold button to jump farther.</i>
<input type="checkbox"/> button + analog stick	<i>Rotate camera.</i>
L button	<i>Reset camera angle and view HUD (page 15).</i>

SWIMMING CONTROLS



analog stick	<i>Swim left, right, forward.</i>
<input type="radio"/> button	<i>Dive. Hold button to dive deeper.</i>
<input type="checkbox"/> button	<i>Interact/Action/Pick up rewards.</i>
<input type="triangle-up"/> button	<i>Fast Stroke.</i>
<input type="cross"/> button	<i>Swim toward the surface/ Surface.</i>
<input type="checkbox"/> button + analog stick	<i>Rotate camera.</i>

Note: When Lara is swimming underwater, her air meter slowly drains. If it runs out, Lara will start to take damage to her standard health bar (page 15). If Lara does not surface for air in time, she will drown.

COMBAT AND ITEM CONTROLS



R button	<i>Fire.</i>
Cycle HUD to grenade or flare icon with ◀/▶ + △ button	<i>Throw grenade/flare.</i>
⬆	<i>Accurate Aim Mode: toggle.</i>
L button (press and hold)	<i>Combat Mode lock-on.</i>
L button	<i>Realign camera behind Lara.</i>
Cycle HUD to grapple icon with ◀/▶ + △ button	<i>Throw grapple.</i>
△ button	<i>Pull grapple/Interact with environmental targets (explosive barrels, etc.).</i>
⬇	<i>Use health pack.</i>
Cycle HUD to weapon icon with ◀/▶ + △ button	<i>Switch weapons.</i>
Cycle HUD to PLS icon with ◀/▶ + △ button	<i>Personal Light Source (PLS) on/off.</i>
Cycle HUD to binoculars icon with ◀/▶ + △ button	<i>Binoculars. Activate the RAD (page 22) by pressing the SELECT button in Binocular view.</i>

DRIVING CONTROLS



analog stick	<i>Steer.</i>
X button	<i>Accelerate.</i>
O button	<i>Brake/Reverse.</i>
R button	<i>Fire weapon.</i>
L button	<i>Select target.</i>
□ button	<i>Shoot hazard target.</i>
⬇	<i>Use health pack.</i>
□ button + analog stick	<i>Rotate camera.</i>



COMBAT

COMBAT STRATEGIES

In combat, always remember these two key elements:

■ KEEP MOVING

Keeping Lara moving is the most important factor in combat; her continually changing position slows the enemy's advance. A moving target is much harder to hit than a static one.

■ MANIPULATE THE ENVIRONMENT

Constantly check for objects in the environment that Lara can manipulate to her advantage. For example, she can thwart enemies by blocking paths, collapsing structures, detonating nearby explosives and releasing obstacles.

AIMING AND FIRING CONTROLS

L button (press and hold)	<i>Lock-on target.</i>
R button	<i>Fire weapon.</i>
L button + □ button + ◀/▶	<i>Change target.</i>
Cycle HUD to grenade icon with ◀/▶ + △ button	<i>Grenade free throw.</i>
L button + cycle HUD to grenade icon with ◀/▶ + △ button	<i>Throw grenade at target</i>

MELEE ATTACKS

■ SLIDE ATTACK

Target enemies while running toward them, then press the ○ button to slide. Lara slides into enemies, knocking them off balance and setting them up for her guns.

■ AERIAL ATTACK

Press the X button twice when close to the enemy. With the first press, Lara jumps at an enemy. As she lands on the enemy, press the X button again to activate slow time, then immediately press the R button to fire, shooting the target.

■ POWER KICK

When near the target enemy, press the □ button to kick the enemy away with Lara's boot.

■ GRAPPLE

Select the grapple from inventory and press the △ button to use Lara's grapple to pull targeted enemies toward her and inflict some damage.

Note: Melee attacks are ineffective against animal enemies.



DEFENSIVE COMBAT CONTROLS

While Lara is locked-on to a target, she can perform various maneuvers to avoid enemy attacks.

- ROLL *Hold the L button, press the analog stick in any direction, then press the O button.*
- FLIP *Hold the L button, press the analog stick in any direction, then press the X button.*

TARGETING

The targeting reticle appears when a target is within sight. The reticle's color changes to indicate the target status:

- GRAY RETICLE *Target is out of range.*
- RED RETICLE *Target is within range at the current distance.*
- BLUE RETICLE *Target can be grappled.*

Tip: If the target is within distance but off-screen, an arrow appears showing the direction of the target's location.

HUD (Head's-Up Display)



WEAPONS, ITEMS AND HEALTH

- HEALTH BAR *The health bar gauge displays Lara's current health level. When Lara's health gets dangerously low, you need to replenish it using a health pack (page 21) if available.*
- USE ITEMS *(PLS, Health Pack, Binoculars) To use an item or gadget from Lara's inventory, press the directional buttons ◀/▶ to select it, then press the Δ button.*

PDA

The PDA is Lara's automatic data capture and wireless communication device. It holds all of her mission data and real time objective and equipment information. Press the SELECT button to access Lara's PDA, which displays the following data:

- OBJECTIVES – Provides Lara with information on her current objectives and overall mission objectives.
- DATA – Provides information for completed missions, and allows you to keep a tally of rewards collected while playing the missions.
 - COMPLETION TIME – Records your fastest time for the mission.
 - COMPLETED TIME TRIAL – Yes/No.
 - GOLD REWARDS – Shows number collected and total rewards available (of each type) in the Mission.
 - SILVER REWARDS – Shows number collected and total rewards available (of each type) in the Mission.
 - BRONZE REWARDS – Shows number collected and total rewards available (of each type) in the Mission.
- GEAR – Provides Lara with information on all her inventory. Here you can view stats and descriptions of each weapon and item Lara has.

EQUIPMENT

HEALTH PACK

A staple of the rough-and-rugged adventurer, health packs allow Lara to treat her injuries in the field.

Note: Lara can carry a maximum of three health packs.

PERSONAL LIGHT SOURCE (PLS)

Ultra-bright LED portable light source. Kinetically charged, the PLS shines for a limited time before shutting off to recharge.



MAGNETIC GRAPPLE

Using her grapple, Lara can manipulate objects from a distance, climb or drop to different heights, and swing across large gaps. The grapple consists of a magnetic grapple head that can latch onto discrete, visually distinct surfaces, plus a lengthy wire and an automatic recoiler.





Note: The grapple can only be used on specific shiny metallic surfaces.





BINOCULARS/ REMOTE ANALYSIS DEVICE (RAD)

The RAD, a pair of high-tech lenses in Lara's inventory, performs the following functions:



- **BINOCULARS** – Magnify the image in the field of view.
- **RAD MODE** – Analyze and provide a readout for objects in view that have significant archeological or technological interest. Data collected include:
 -  **CHEMICALLY UNSTABLE** – Object explodes given the right impulse.
 -  **TECHNICAL** – Object is part of machinery large or small, ancient or modern, electronic or physical.
 -  **MOVABLE** – Object can be moved, either with direct Lara interaction or by other means.
 -  **PHYSICALLY UNSTABLE** – Object can be made to topple or break.

USING THE BINOCULARS/RAD

- Press   +  button to activate the binoculars in inventory. Press and hold the R or L button to zoom in or out.
- Press the SELECT button to activate RAD mode. (Press again to deactivate.)

REWARDS

Throughout Lara's archeological adventure, various artifacts and relics become available for discovery and collection. Collecting rewards opens up bonus content and extra features such as outfits (which you can view in Croft Manor), pistol upgrades, concept art and much more. Make sure Lara scours the environment thoroughly.

Each mission has various different types of collectables:

- **BRONZE REWARDS** – Informational content.
- **SILVER REWARDS** – Game content.
- **GOLD REWARDS** – Special game rewards.

Note: The most valuable unlockables are only obtained by collecting a combination of all three reward types. When each level is complete, you will be notified about which type of reward(s) you have managed to unlock. Select EXTRAS from the Main Menu to view and select your rewards.

Tip: Select LOAD LEVEL from the Main Menu to replay completed missions and pick up missed rewards.



CREDITS

DEVELOPMENT TEAM

Senior Producer
Matthew Guzenda

Producer
Morgan Gray

Production Staff
Alex Jones, Lulu LaMer, Elio Rutigliano, Rosaura Sandoval, Nate Schaumberg

Additional Production
David Baker, Juli Logemann

PROGRAMMING STAFF

Technical Director
Jason Bell

Lead Programmer
Rob Pavey

Player Character Lead Programmer
Gary Sneath

Senior Programmers
Scott Krotz, Erin Catto

Programmers

Joshua Criz, Darrell Dennies, Matthew Gaston, Sean Gugler, Komei Harada, Anne-Lise Hassenklover, Andrew Hynck, David Modiano, Hong Park, Stephen Perez, Sean Skelton, Anthony Thibault

Additional Programming

Dan Archard, Stanislav Baranov, Michael Davies, Nathan Frost, Mike Gonzales, Joel Hunter, Ted Johnson, Thomas Mayer, Matthew McKinnon, Paul Taylor, Meilin Wong

Scripting

Tom Fong, Brad Johnson, Josie Nutter, Matt Roberts

ART STAFF

Art Director
Jacob Wendler

Lead Artists
Jason Botta, Drew Medina

Artists
Matthew Abbott, Lucas Aceituno, Scott Anderson, Matt Bein, Jim Conrad, Chris Gregory, Yaroslav Grabovskyy, Yu Gu, Jeff Johnsrude, Justin Lamperski, Freddie Lee, Shao Wei Liu, Dan Neuberger, Ross Patel, Kristen Russell, Patrick Sirk, Caleb Strauss, Chris Strugill, Andrew Wood

Visual Effects Lead

Gavin Wood

Environment Concept Art
Joel Boucquemont, Bill Stoneham

Lara Design & Creative Consultant
Toby Gard

Lead Character Designer
Kam Yu

Lead Character Artist
Daniel Cubuco

Character Artists
Chris Anderson, David Gustin

Lead Animators
Brandon Fernández, Jeff Wilcox

Animators
Ryan Goldsberry, Ben Harrison, Barry Nardone, Michael Smith, Jake Spence

Animation Intern
Shaun Budhrum

DESIGN STAFF

Lead Designer
Riley Cooper

Assistant Lead Designer
Harley Baldwin

Lead Level Designer
Martin Dufour

Designers
Jeremy Bredow, John Dumala, Steve Goodale, Jesse Johansen, Kyle Mannerberg, Darren Mckinsey, Matt McManus, Stephen McManus, Jon Vosovic, Jason Weesner, Steve Yoshimura

Story Designer

Eric Lindstrom

Dialogue Writer

Aaron Vanian

AUDIO STAFF

Music Composed by
Troels B. Folmann

Audio Engineer
Karl Gallagher

Sound Designer
Mike Peaslee

Junior Sound Engineer
Gregg Stephens

Creative Services Director
David Goodwine

Title Sequence Created by
Jake Hughes

AV Support

Estuardo Sandoval

AV Interns
Rick Gilliland, Jae Shin

Playtest Coordinator

Daniel Atkins

Original Design

Doug Church

Voice Acting

Lara Croft Keeley Hawes
Zip Alex Desert
Alistair Greg Ellis
Winston Alan Shearman
Amanda Kath Soucie
Anaya Melissa Lloyd
Rutland Rino Romano
Nishimura Paul Nakauichi
Takamoto Michael Hagiwara
Narrator Alister Duncan
Archeologist (Kent) Alister Duncan
Lady Croft Eve Karpff
Child Lara Charlotte Sparey

Voice Director (US)

Jonathan Ashley

Voice Director (UK)

Kris Zimmerman

Voice Consultant (UK)

Andy Emery

Voice Consultant

Gordon Hunt

SPECIAL THANKS

Joe Allen, Marianne Arotzarena, Eric Beerbaum, Kim Chew, Rolf Conlan, Patrick Connor, Rusty Drake, Mike Ellis, Jennifer Fernández, Rutherford Gong, Austin Grossman, Jon Guilford, Jim Hedges, David Hong, Noor Khawaja, Sam Kolb, Richard Lemarchand, Art Matsuura, Martin McDonald, Billy Mitchell, Robert Quattlebaum, Calvin Rein, Cory Ringdahl, Andre Rodriguez, Sally Short, Ian Slutz, John Spinale, Alex Vaughan, Brian Venturi, Mark Wilhelm, Salami Studios (US), Side (UK), Everyone at Crystal Dynamics for their support!

The Tomb Raider Development team would like to thank our families, husbands, wives, children, significant others, pets and everyone else who helped us during the making of Tomb Raider: Legend. We could not have made it without you!

BUZZ MONKEY SOFTWARE

Senior Producer
Randy Thompson

Producer
RD Wegener

Lead Programmer
Brian Appgar

Programmers
Michael D C Mack, Stan Patton, Eldon Rivers, Jacob Voll, Derick Wiant

Additional Programming
Steve Cordon, Jon Milnes

Lead Artist
John C. King

Artists
Eric Blondin, Jason Ford, Matt Morgaine, Greg Reinmuth, Tyrone Woodland

Lead Designers
Vince Castillo, Marshall Gause

Designers
Lucas Crispin, Kevin Wjenczek

Lead QA
Garrett Turner

QA
Jake Martin, Scott Woolley

Special Thanks
The Buzz Monkey Tomb Raider PSP Development team would like to thank all of our families and friends for their support during the making of Tomb Raider Legend.

CRYSTAL DYNAMICS

General Manager
Sean Vesce

Director of Production
Graeme Bayless

Director of Design
Noah Hughes

Director of Technology
John Pursey

Director of Art
Darrell Gallagher

Quality Assurance Manager
Chris Bruno

Lead Tester
Benny Ventura

Platform Leads

Bill Gahr, John Hsia, Daniel Kim,
Oliver Villa Piegna

Testers

David Pogan, John Allen,
Flynn O'Hare, Bryan Enriquez

E IDOS UK

CEO

Jane Cavanagh

Commercial Director

Bill Ennis

Financial Director

Rob Murphy

Company Secretary

Anthony Price

Head of European Publishing

Scott Dodkins

Product Acquisition Director

Ian Livingstone

Worldwide CTO

Julien Merceron

Development Director

Darren Barnett

Senior Producer

Greg Hounsom

Creative Development Director

Patrick O'Luanigh

Executive Designer

Dax Ginn

Head of Global Brand

Larry Sparks

Senior Brand Manager

Matt Gorman

Brand Manager

Alex Price

Head of Support Services

Flavia Timiani

Senior Localisation Manager

Monica Dalla Valle

Localisation Manager

Guillaume Mahouin

Creative Manager

Quinton Luck

Senior Designer

Jodie Brock

Designer

Philippa Pratley

QA Manager

Marc Titheridge

QA Supervisor

Dave Pettit

QA Lead Technicians

Richard Abbott, Tyrone O'Neill,
Andrew Standen, Anthony Wicker,
George Wright

QA Technicians

Dominic Andoh, Sam Beard,
Warren Beckett, Neil Delderfield,
Jonathan Fuguet, James Hinchliffe,
Hugo Hirsh, Alistair Hutchison,
David Klein, Daniel Mills,
Mark Parker, Garth Philip,
Matthew Poon, Jonathon Redington,
David Sangan, Daniel Webster

Special Thanks

A big thanks to all our European Marketing, Sales and Web teams as well as our Finance department who have done a wonderful job to make this game happen. Your tremendous work is much appreciated. A big thanks also to Tom Waine for writing this manual

E IDOS US

*CEO & President,**Idos North America*

Bill Gardner

*Executive Vice President**of Sales & Marketing*

Robert Lindsey

*Vice President of Legal**& Business Affairs*

James O'Riordan

Vice President of finance

Malcolm Dunne

*Vice President**of Human Resources*

Edie Dykstra

National Sales Manager

Joe Morici

Global Brand Manager

Matt Gorman

Associate Marketing Manager

Mike Schmitt

Director of Public Relations

Michelle Seebach Curran

Public Relations Manager

Tali Fischer

Senior Public Relations Manager

Loretta Stevens

Online Community Specialist

Matt Daighren

Channel Marketing Manager

Janty Sumimoto

*Senior Channel**Marketing Specialist*

Ilana Budanitsky

Channel Marketing Coordinator

Rafal Dudzic

*Director of Marketing**Communications*

Stephanie Lipetzky

Web Producer

Roderick van Gelder

Web Designer

Boon Khoo

*Creative Services**Project Manager*

Eileen Buenviaje

Media Specialist

Micheal Tran

Graphic Designer

James Song

Events Specialist

Annie Meltzer

Music Licensing

Kevin Gill

Publishing Support Coordinator

Clint Waasted

Operations Manager

Gregory Wu

Senior External Producer

Nick Goldsworthy

Associate Manager of Product Operations

Colby McCracken

*Quality Assurance/**Customer Service Manager*

Mark Cartwright

QA Supervisors

Dan Franklin, Aaron Saronoff

Lead QA Technician

Elizabeth Rutlin

Assistant Lead QA Technicians

David Bushee, John Hayes

Quality Assurance Technicians

Katie Bieringer, Jonathan Brown,
Richard Campbell,
Nicholas Coopridge, Ergin Derisoglu,
Wil Dimas, Kip Ernst, Joe Greer,
Stephanie Greer, Richard Hartzell,
Mackenzie Hume, Nick Jacobson,
Jason Johnson, Aaron Keillor,
Erik Kennedy, Chester Lee, Jeff Lowe,
Nicholas Lutz, Peter Panagiotis,
Tony Perata, Joshua Pfeiffer,
Brandon Reed, Matthew Trudell,
Clint Waasted

Special Thanks

Kjell Vistad, Ashley Schwartz,
Stefania Clapci,
Hanshaw Ink & Image



BECAUSE X NEVER MARKS THE SPOT

Six months in the making, and designed with exclusive insight and assistance from the Crystal Dynamics development team, *Tomb Raider - The Complete Guide* is an essential companion for those who would like to enjoy Lara's latest adventure to its fullest.

Key Features:

Unique two-speed walkthrough enables players to either find hints as required, or follow step-by-step guidance

Comprehensive "Secrets" chapter, discover the location of every single Gold, Silver and Bronze Reward, and learn about the bonus features they unlock

How to master control of Lara, with every move explained and explored

Dozens of detailed annotated maps provide an at-a-glance guide to every locale Lara visits

Includes tried-and-tested combat strategies and techniques

Features an exclusive behind-the-scenes interview with the *Tomb Raider Legend* development team, plus background information on the *Tomb Raider* story to date

Tomb Raider Legend - The Complete Guide is on sale now. Visit www.piggybackinteractive.com for free sample pages and further details.

S.R.P. USA: \$ 16.99
S.R.P. Canada: \$ 23.95

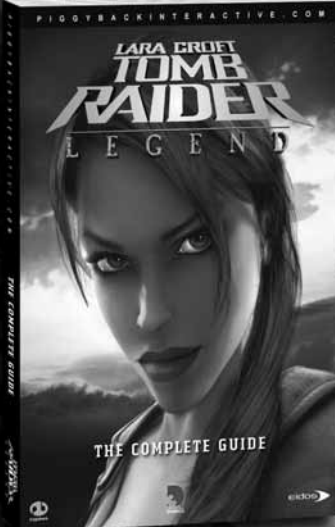

Unearth every last secret, sight and solution with *Tomb Raider Legend - The Complete Guide*

© 2006 Piggyback Interactive Limited. All rights reserved. Piggyback, PIGGYBACKINTERACTIVE.COM and the Piggyback logo are trademarks of Piggyback Interactive Limited.

Lara Croft, *Tomb Raider: Legend* © 2006 Core Design Ltd. Developed by Crystal Dynamics, Inc. Published by Eidos, Inc. TM: Lara Croft, *Tomb Raider: Legend*, Lara Croft, *Tomb Raider: The Complete Guide* and the Eidos logo, Crystal Dynamics and the Crystal Dynamics logo are trademarks of SCI Entertainment Group.



Register online at
www.eidosregistration.com

EIDOS, INC., LICENSE & LIMITED WARRANTY

Eidos, Inc., warrants to you, the original purchaser of this disc, that for a period of ninety (90) days from the date of your purchase, this disc shall be free from defects in materials and workmanship. If, at any time during the applicable ninety (90) day warranty period you determine that this limited warranty has been breached, Eidos, Inc., agrees, in its sole option, to repair or replace, free of charge, any such disc, provided the disc is returned postage-paid to the Eidos, Inc., Factory Service Center and a proof of date of purchase is included. This limited warranty is not applicable to normal wear and tear and shall be void with respect to any defects that arise from disc abuse, unreasonable use, mistreatment or neglect. This disc is sold "as is" without any warranties of any kind, express or implied, including implied warranties of merchantability or fitness for a particular purpose, other than the limited warranty expressly stated above.

No other claims arising out of your purchase and use of this disc shall be binding on or obligate Eidos, Inc., in any manner. Eidos, Inc., will not be liable to you for any losses or damages incurred for any reason as a result of your use of this disc, including, but not limited to, any special, incidental, or consequential damages resulting from your possession, use or malfunction of this disc.

This limited warranty states the entire obligation of Eidos, Inc., with respect to the purchase of your disc. If any part of this limited warranty is determined to be void or illegal, the remainder shall remain in full force and effect.

For warranty support please contact our Customer Support department at (415) 615-6220. Our staff is available Monday through Friday, 9:00 a.m. to 12:00 noon and 1:00 p.m. to 5:00 p.m. Pacific Time. You are responsible for all toll charges. Customer Support Representatives will not provide game hints, strategies or codes.

PRODUCT RETURN PROCEDURE

In the event our support agents determine that your game disc is defective, you will need to forward material directly to us. Please include a brief letter explaining what is enclosed and why you are sending it to us. The agent you speak with will give you an authorization number that must be included and you will need to include a daytime phone number so that we can contact you if necessary. Any materials not containing this authorization number will be returned to you unprocessed and unopened.

Send your postage-paid package to the following address:

Eidos, Inc. Customer Services
RMA# (state your authorization number here)
651 Brannan Street, Suite 400
San Francisco, CA 94107

You are responsible for postage of your game to our service center.

Lara Croft *Tomb Raider: Legend* © 2006 Core Design Ltd. Developed by Crystal Dynamics, Inc. Published by Eidos, Inc. 2006. Lara Croft *Tomb Raider: Legend*, Lara Croft, *Tomb Raider*, the *Tomb Raider* logo, Eidos and the Eidos logo, Crystal Dynamics and the Crystal Dynamics logo are all trademarks of SCI Entertainment Group. Jeep® is a registered trademark of DaimlerChrysler Corporation. Jeep® Wrangler® Rubicon®, Commander and their trade dress are used under license by DaimlerChrysler. ©DaimlerChrysler Corporation 2006. DUCATI LOGOS are all trademarks of Ducati Motor Holding S.p.A. The Buzz Monkey logo is a trademark of Buzz Monkey Software, LLC. The ratings icon is a registered trademark of the Entertainment Software Association. All other trademarks are the property of their respective owners. All rights reserved.

The communications function of this product includes software developed by the NetBSD Foundation, Inc. and its contributors. For a complete list of contributors please see <http://www.scei.com.jp/psp-license/pspnet.txt>